

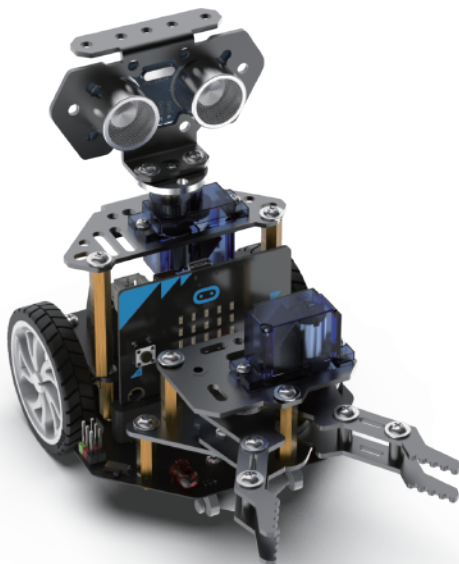

DFROBOT
DRIVE THE FUTURE

Maqueen Mechanic



Installation Manual



Part List



● Loader Servo Panel



● Loader Bucket



● Pan-tilt-zoom
Mount Plate

×2



● Trolley Plate



● Ultrasonic Mount
Holder



● Arm Servo Base



● Arm Baseplate



● Arm Linkage

×3



● Arm Plate



● Servo Arm Linkage



● Forklift Plate



● Gripper Upper Arm

×2

Part List



● Gripper Driven Forearm



● Gripper Servo Forearm



● Gripper Panel



● Gripper Triangular Mount Plate



● M3*35mm Copper Bolt

×2



● M3*25mm Copper Bolt

×2



● M3*15mm Copper Bolt

×6



● M3*18mm Copper Bolt

×3



● Servo

×2



● M2.5*5mm Screw

×12



● M3*5mm Screw

×45



GO!



Assemble and Install

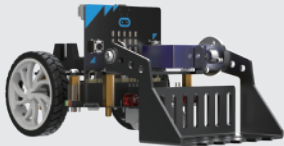

Loader

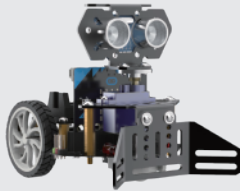

Bulldozer

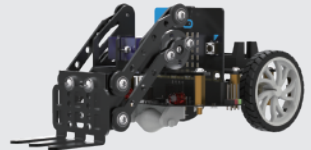

Forklift

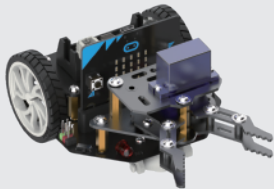

Mechanical Beetle

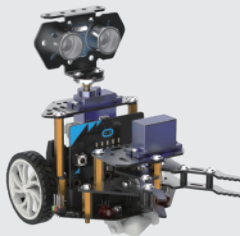

**Pan-tilt-zoom
Mechanical Beetle**

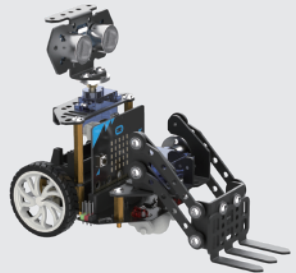

Pan-tilt-zoom Forklift



Pan-tilt-zoom Loader



Loading Truck

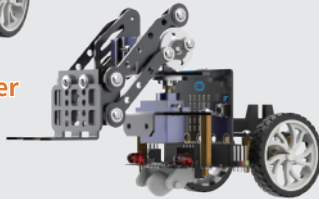

Rotating Forklift

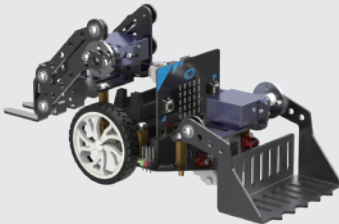

**Multi-Purpose
Engineering Vehicle(MPEV)**

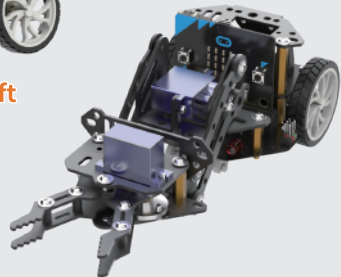

**Liftable
Mechanical Beetle**



Install Loader

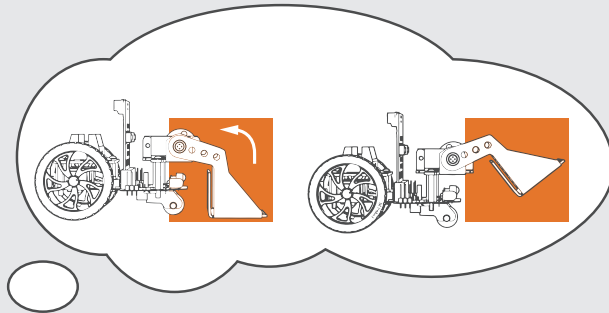

Install Loader

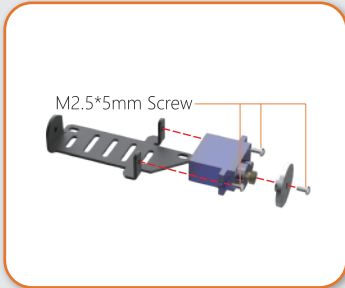

● Step1

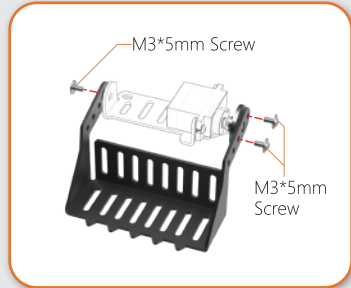

● Step2

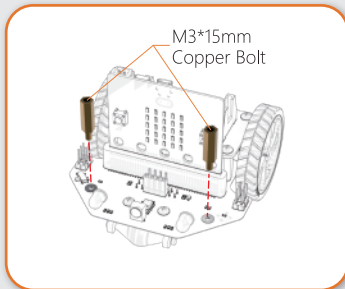

● Step3

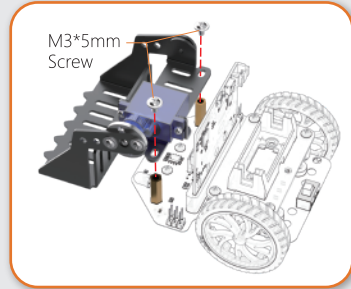

● Step4



Install Bulldozer

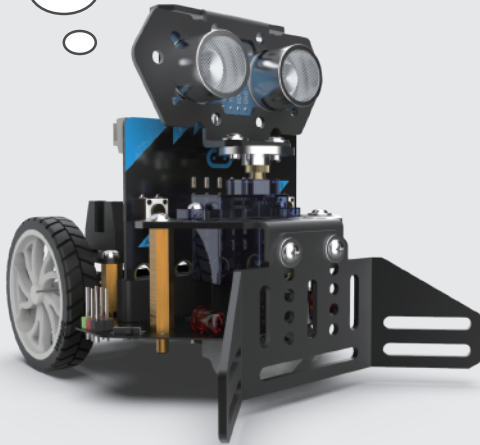
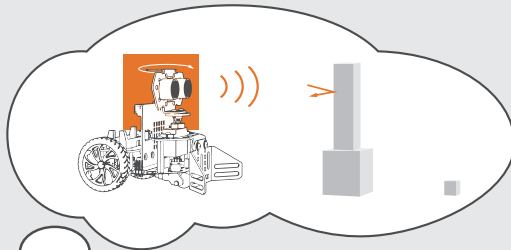

Install Bulldozer



● Step1

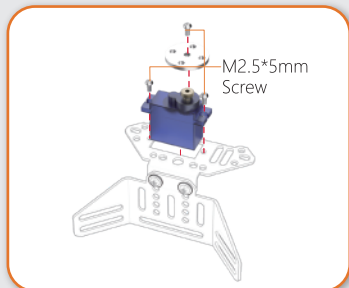

● Step2

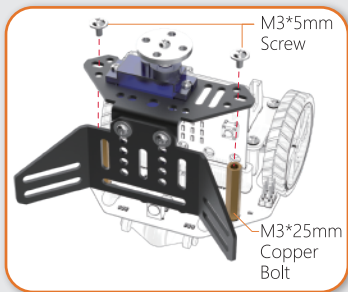

● Step3

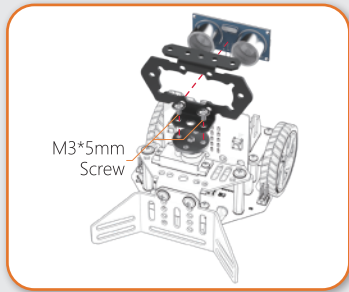

● Step4



Install Forklift

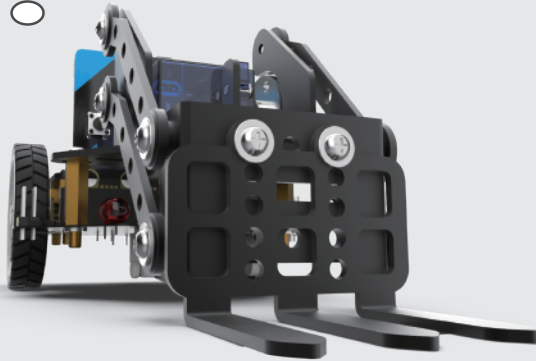
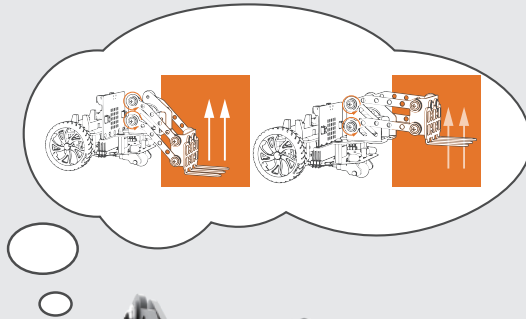

Install Forklift

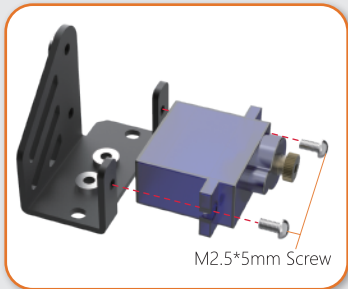

● Step1

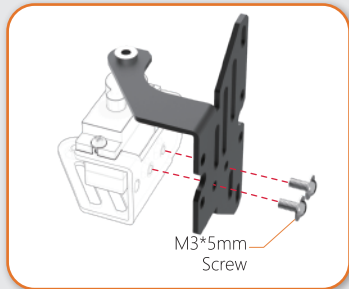

● Step2

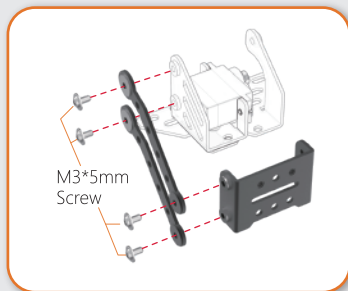

● Step3

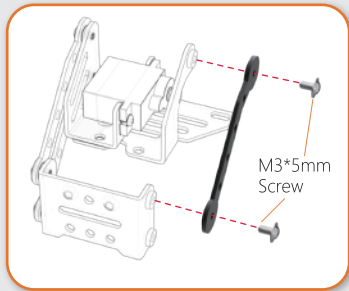

● Step4



Install Forklift

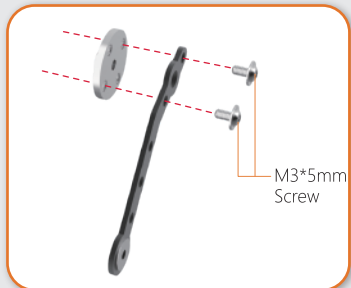

● Step5

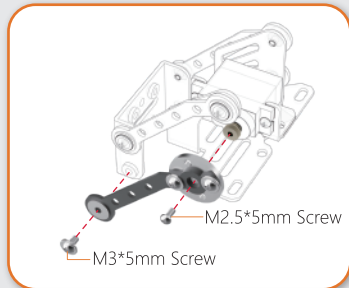

● Step6

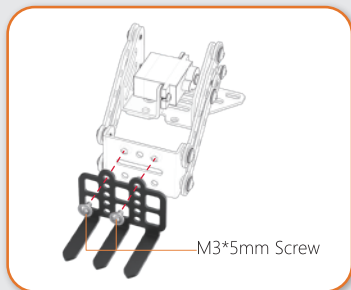

● Step7

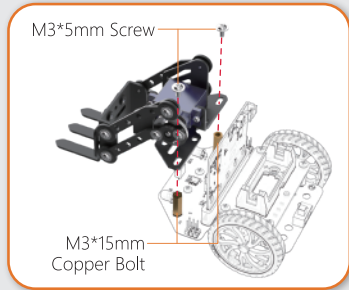

● Step8

Install Mechanical Beetle

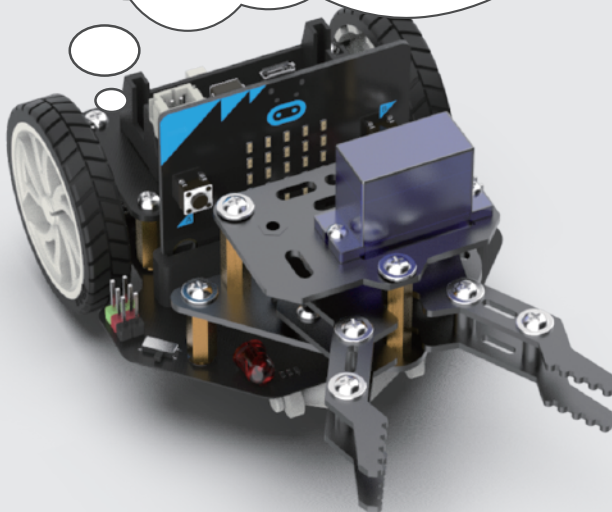
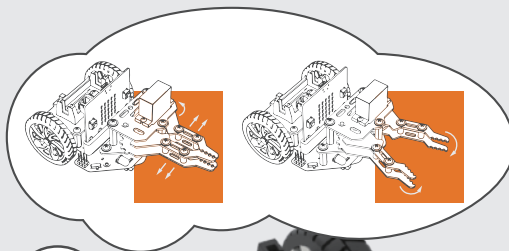



Install Mechanical Beetle

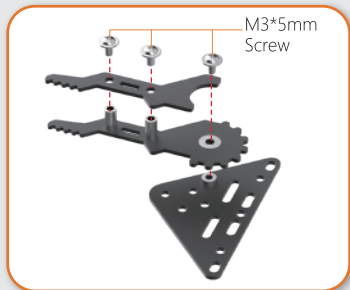

● Step1

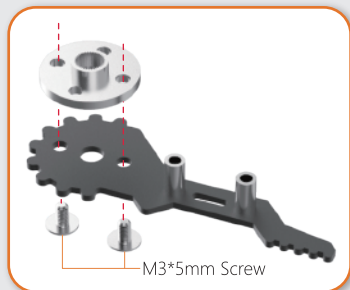

● Step2

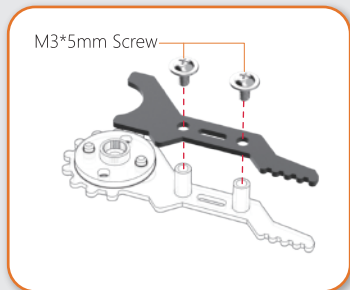

● Step3

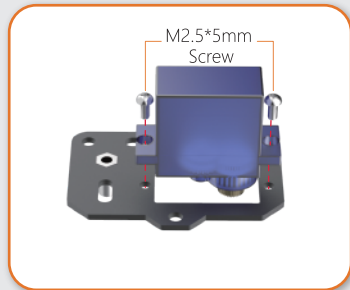

● Step4

Install Mechanical Beetle

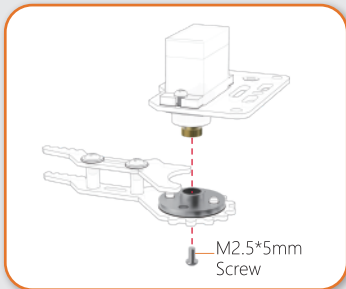

● Step5

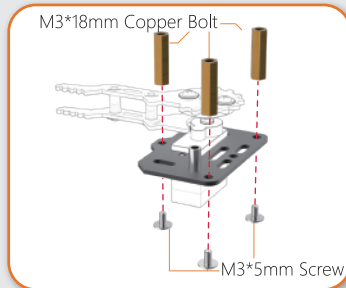

● Step6

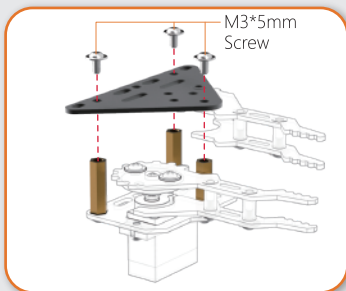

● Step7

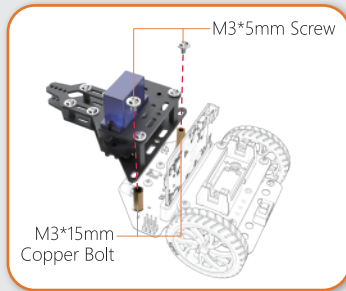

● Step8



Install Pan-tilt-zoom Mechanical Beetle

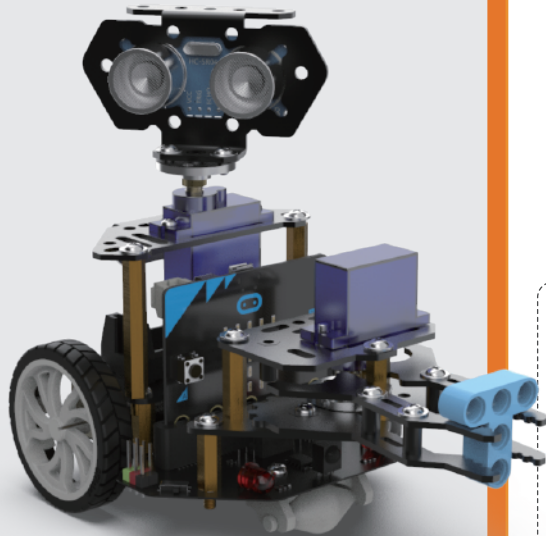

Diagram

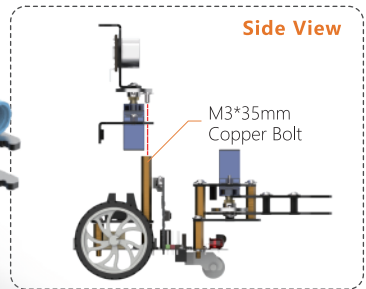
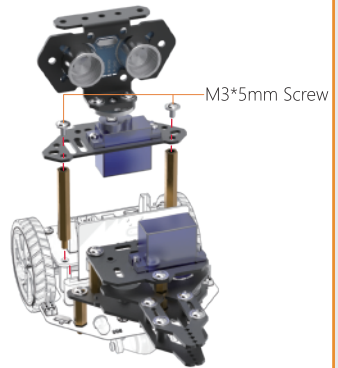

Install Pan-tilt-zoom Forklift

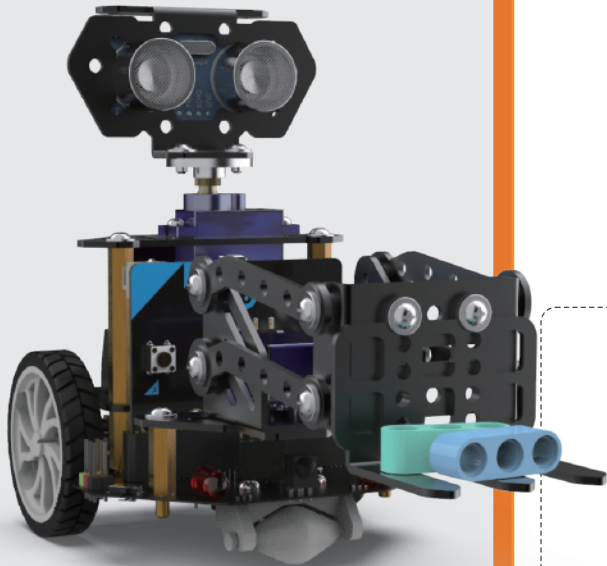

Diagram

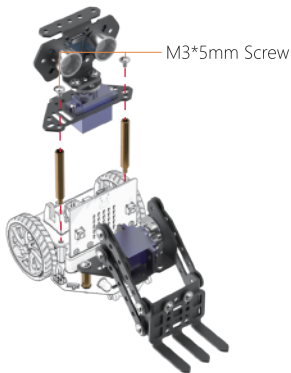

Side View

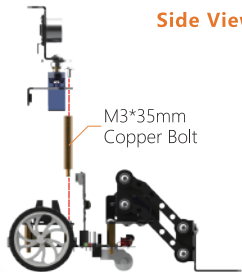



Install Pan-tilt-zoom Loader

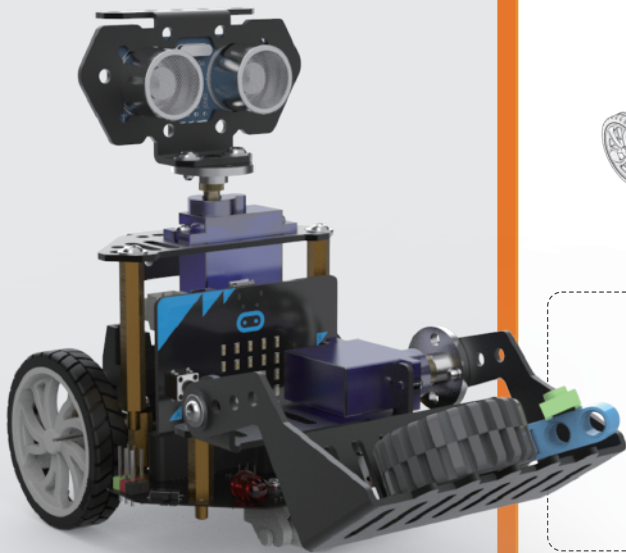

Diagram

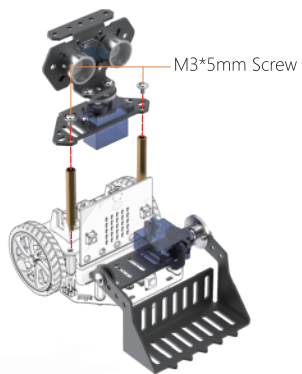

Side View

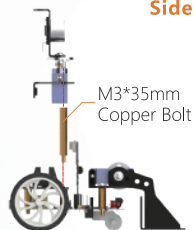

Install Rotating Forklift



Diagram

M3*5mm Screw

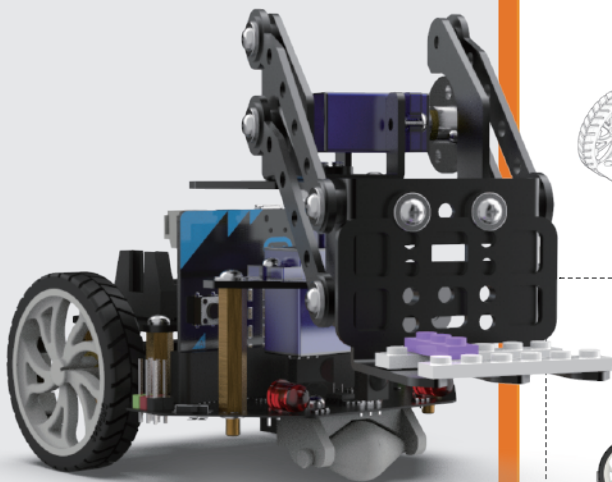
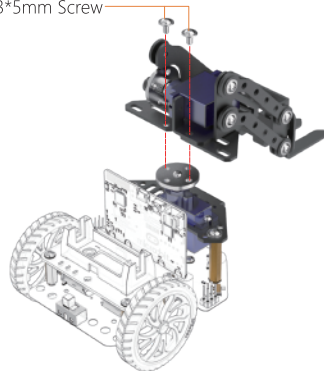

Side View

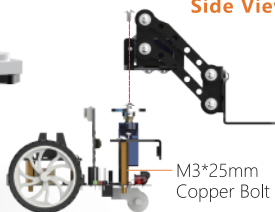

M3*25mm
Copper Bolt



Install Loading Truck

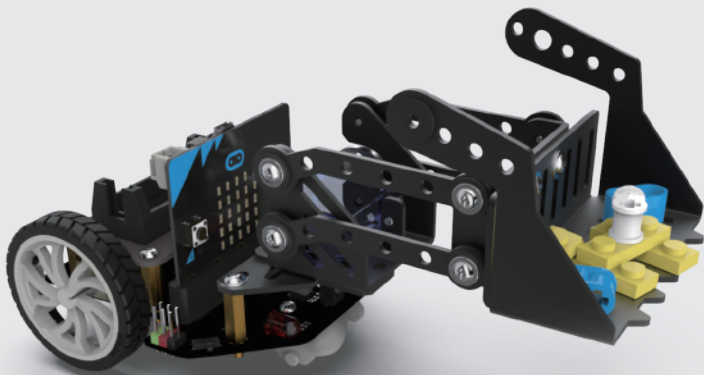

Diagram

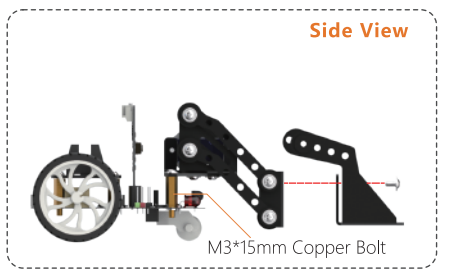

Install MPEV

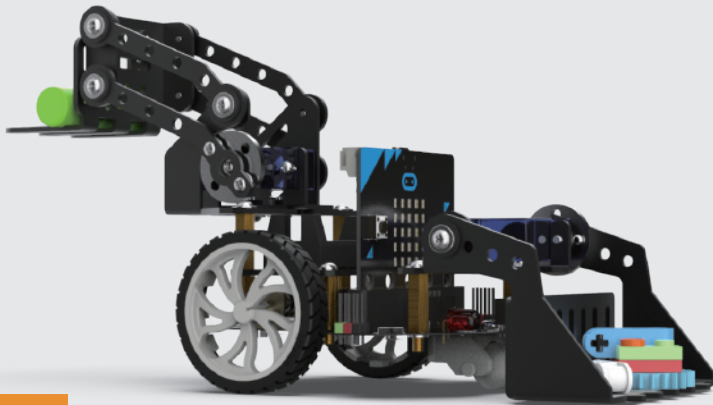

Diagram

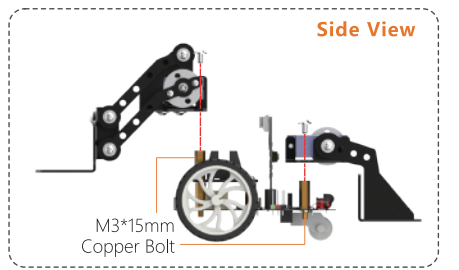
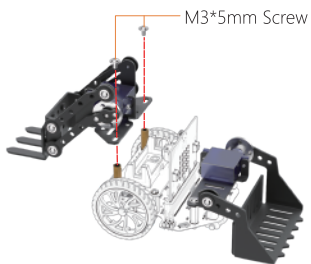



Install Liftable Mechanical Beetle

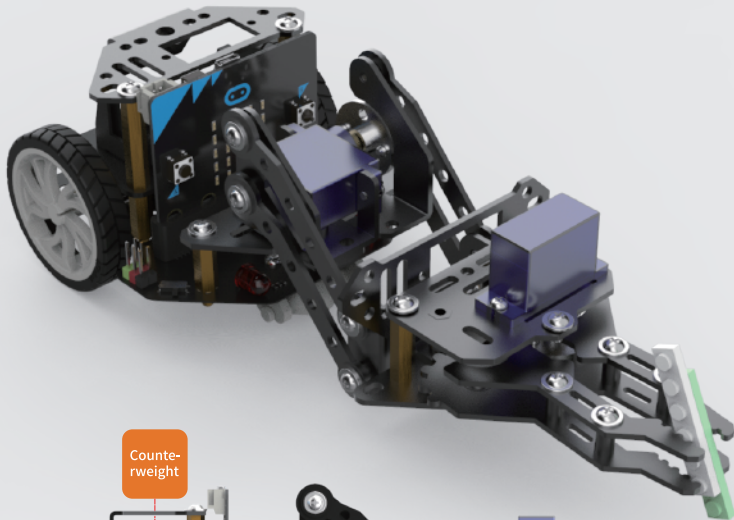

Counte-
rweight

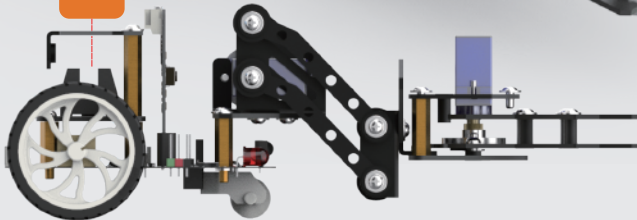

Install Liftable Mechanical Beetle



Diagram

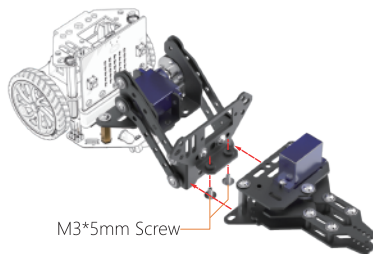
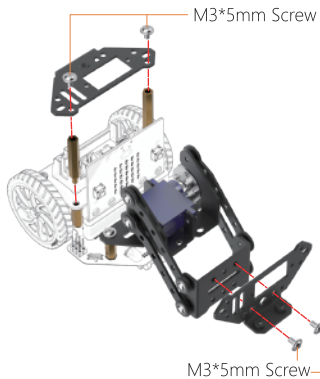

Side View

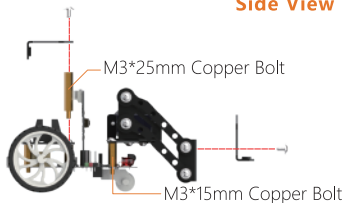

Side View

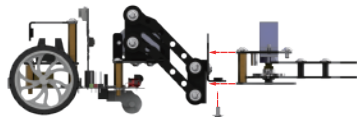



Welcome to
www.dfrobot.com
for more details